

**Hilker** 1888  
Germany



MEISTER OF  
SLEEP ENGINEERING

REGALBURG COLLECTION

# **SPINASHIELD**

HYBRID SYSTEM

## SUPREME SPINE SUPPORT ULTIMATE BACK CARE SYSTEM

Besides optimum spine alignment, our mattresses are carefully designed and made with the thought of ultimate back care by combining a variety of premium components. For Hilker Mattress, we have the hybrid design of High-resilience and High-density Caring Foam on top of the dedicated Ti-core® Titanium Pocketed Spring system.







**TI-CORE®**

## TITANIUM POCKET SPRING



SGS-TESTED & CERTIFIED TITANIUM  
USED ACROSS ALL HILKER SPRING MATTRESSES

As the meister of sleep engineering, we are constantly striving to provide world-class mattresses to our prestigious customers. We are proud to announce that all our spring mattresses are made of the extraordinary Ti-core® Titanium Pocket Spring, offering the most durable metal component to support your body throughout your soothing sleep.

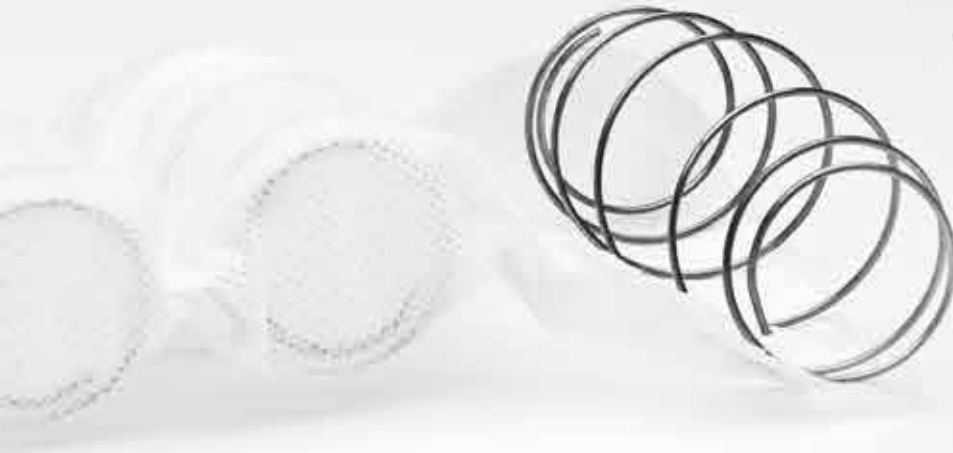

## **DURABLE TITANIUM**

Lightweight, strong, and corrosion-resistant. A spring system entirely made of Titanium has great resistance and maintains strength for years to come.



## **NEUTRALISE HARMFUL EMF**

Neutralize harmful electromagnetic fields (EMF) from all electronic devices to protect your body from their damaging effects and improve sleep quality.



## **LESS PARTNER DISTURBANCE**

The durable titanium spring is wrapped individually with an isolated non-woven pocket, reducing motion transfer even when your sleep partners toss and turn around at night.

TITANIUM  QuadHDCoil®

# FULLY RE-CHARGED WITH QUAD-HD-COIL® SPRING SYSTEM



**3 PARALLEL  
+ 1 HONEYCOMB**

The spring system is designed with 3 layers of parallel composition and 1 layer of honeycomb composition, which gives an extra body weight and pressure distribution continuously throughout your sleep.



**UP TO 10,000  
SPRING COUNT**

The 4 layers of mini 60mm Ti-core® pocketed springs contribute up to 10,000 spring count, provide an optimum comfort level and complete body support for a restful and rejuvenating sleep.



**28 TIMES  
MORE COMFORT**

An ordinary spring mattress has about 300-400 spring count. QuadHDCoil® features 28 times more spring count hence 28 times more support, resilience, and comfort than one's average sleep experience.



**NEUTRALISE  
HARMFUL EMF**



**60MM MINI  
TI-CORE®**

Each coil is made with extra durable, anti corrosion Titanium in 60mm size, able to support and neutralise harmful electromagnetic field throughout our body from head to toe in a more precise manner.



**COMFORT  
BOOSTER**

With the precision body support of 60mm mini Ti-core® pocketed springs, it enhances the overall level of comfort and gently conforms to your body contour, allowing your spine to rest comfortably at the optimal level.



**ADVANCED  
PRESSURE RELIEF**

The ergonomic design of 60mm mini Ti-core® pocketed springs creates a wider support surface on your body, offering an advanced body weight and pressure relieving function at all sleeping positions.



IN  $\approx$ 60MM  
MINI SIZE

 **TriHDCoil<sup>®</sup>**

**3 LAYERS OF MINI TI-CORE<sup>®</sup>**  
**20 TIMES MORE COMFORT**



1

2

3

With a combination of 2 parallel layers and 1 honeycomb layer of 60mm mini Ti-core<sup>®</sup> pocket springs, this innovative design system offers an incredibly comfortable sleep experience with up to 8,000 spring counts, 20 times more comfortable than an ordinary spring mattress.

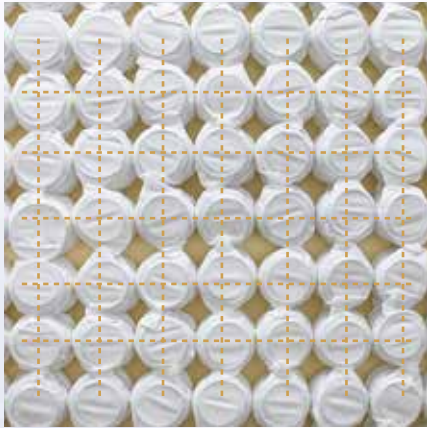

## LAYER 1 2

### PARALLEL COMPOSITION

The main difference between the parallel and the honeycomb composition is its total spring count per layer. The gap between the independent pocket spring of parallel composition is wider than the honeycomb, which makes it greater resilience in general.

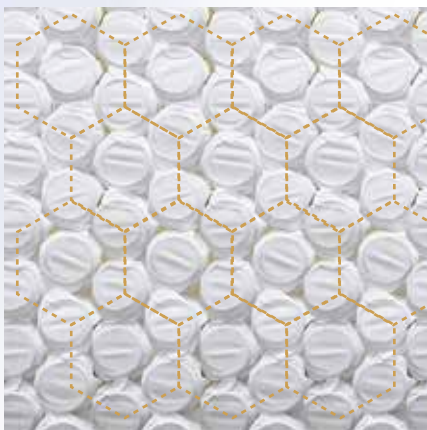

## LAYER 3

### HONEYCOMB COMPOSITION

We have the honeycomb composition as the foundation of our Tri-HDCoil® spring system, to strengthen the base support of the mattress. It has more spring count per layer as compared to the parallel composition, hence more compact and provides firmer support for our total body care.

ORDINARY  
SPRING MATTRESS

=

ESTIMATED 400  
SPRING COUNT

---

TRI-HDCOIL®  
SPRING SYSTEM

=

UP TO 8,000  
SPRING COUNT

---

20 TIMES MORE  
SPRING COUNT

=

20 TIMES MORE  
COMFORT SLEEP



MATTRESS TOP VIEW COMPARISON

### REGULAR POCKET SPRING

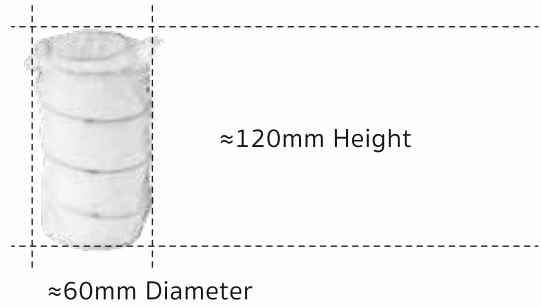

### MINI TI-CORE® POCKET SPRING



**50% SMALLER\***  
**BUT GREATER**  
**PRESSURE**  
**POINT RELIEVING**

\*50% smaller in pocket spring height and diameter



TOUGHEST SUPPORT

# Most Durable & Advanced Body Pressure Relieving

Our Ti-core® Titanium Pocket Springs are tested and certified by SGS, ensuring you the most durable metal component as compared to the other metal alloys. On top of that, we are using the **60mm mini size Ti-core®** to construct this prestigious mattress system, giving you a finer body zone support hence the most advanced body pressure relieving and soothing sleep.

---

≈60MM VERSUS ≈38MM SPRING DIAMETER

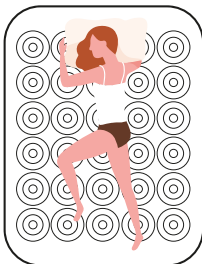

The regular pocket springs are approximately 60mm spring diameter

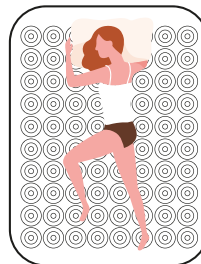

But our Mini Ti-core® is 50% smaller at approximately 38mm spring diameter, which comparatively **supports a finer body zone**



TITANIUM  **DuoHDCoil®**

## 2 LAYERS OF TI-CORE® 5 TIMES MORE COMFORT

The Duo-HDCoil® spring system is constructed with 2 layers of Regular Ti-core® Titanium Pocket Springs where the top layer is in parallel composition and the bottom layer is in a firmer honeycomb composition. The remarkable spring system gives us up to 2,000 spring counts, 5 times more comfortable than an ordinary spring mattress.



## LAYER 1

### PARALLEL STRUCTURE

The main difference between the parallel and the honeycomb composition is its total spring count per layer. The gap between the independent pocket spring of parallel composition is wider than the honeycomb, which makes it greater resilience in general.

## LAYER 2

### HONEYCOMB STRUCTURE

We have the honeycomb composition as the foundation of our Duo-HDCoil® spring system, to strengthen the base support of the mattress. It has more spring count per layer as compared to the parallel composition, hence more compact and provides firmer support for our total body care.

ORDINARY  
SPRING MATTRESS = ESTIMATED 400  
SPRING COUNT

---

**DUO-HDCOIL®  
SPRING SYSTEM = UP TO 2,000  
SPRING COUNT**

---

**5 TIMES MORE  
SPRING COUNT = 5 TIMES MORE  
COMFORT SLEEP**

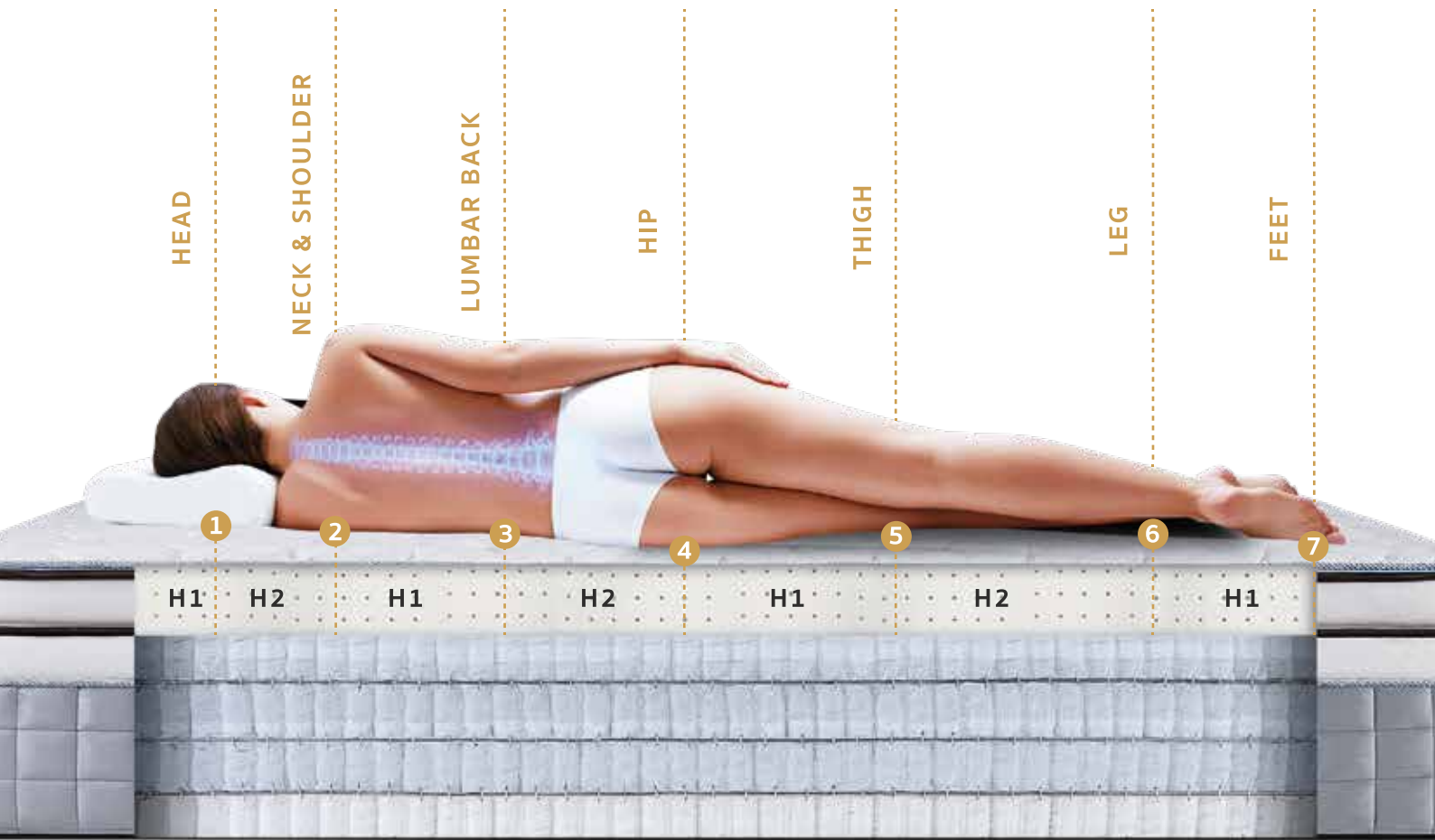

H1 = FIRMER | H2 = SOFTER



## TARGETED BODY ZONES SUPPORT

Designed with a targeted level of firmness according to specific 7 body zones from head to toe, NOVAYA 7-zone natural latex allows your spine to rest at the optimal level at all sleeping positions.



## MAXIMUM AIR REGULATION

Thoughtfully designed with pin-holes structure to allow maximum ventilation where air regulates smoothly with or without body pressure. Significantly maintain a hygienic sleep environment.



## ALLERGEN-RESISTANT BY NATURE

All NOVAYA natural latex are tapped from the finest rubber trees, which are naturally dust-mite resistant and allergen-free, making them ideal for those susceptible to allergies.

# ECO-FRIENDLY NATURAL LATEX FROM BELGIUM, ALSO IN 7 ZONES.



Natural latex is a crucial mattress component because it helps the overall air distribution, keeping our sleep environment soothing and refreshing at all times. We partnered with the world's most trustworthy latex supplier from Belgium, using the premium grade eco-friendly natural latex that comes with dedicated 7 zones body support and reformulated latex in this collection.



euroLATEX  
ECO STANDARD



LGA  
CERTIFICATION



ECO-INSTITUT  
CERTIFICATION



# COOLER

## Deep Sleep on **A Cool Bed!**

Sleep...the essential for a healthy life. Considering we spend a third of our lives asleep, the importance of sleep is all the more apparent. Staying cool is an important component of good sleep.

A certain drop in body temperature is to be expected before falling asleep. High ambient temperature makes it difficult for the body to reduce its temperature. It's difficult for the body to reduce its temperature when the ambient temperature is high, making it difficult to fall asleep. Reduced body temperature makes it easy to fall asleep and improves sleep quality. That's why sleep technology leader BOYTEKS developed Cooler mattress ticking.

# COOLER



SCAN QR CODE  
TO WATCH VIDEO

## COOLER FABRIC



### COOLER Mattress Ticking Technology

Cooler mattress ticking technology's heat transfer quality is higher than that of natural and synthetic fibers. Thanks to its production technology, Cooler mattress ticking provides a sense of cool that helps the body stay cool. Cooler maximizes sleep quality by providing a relaxing sleep environment.

Feel refreshed, and fall asleep quicker with the extra comfortable sleep environment provided by Cooler mattress ticking.

## POLYESTER FABRIC



### Test Reports

Simulated skin tests with Cooler and other fabrics have shown Cooler to keep skin temperature 1.3 °C lower.

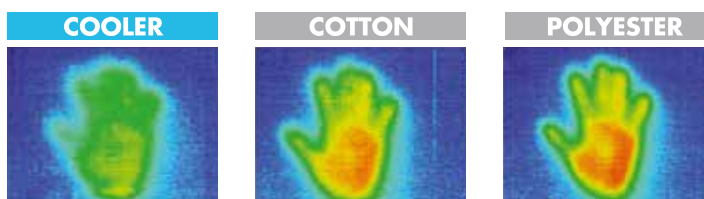

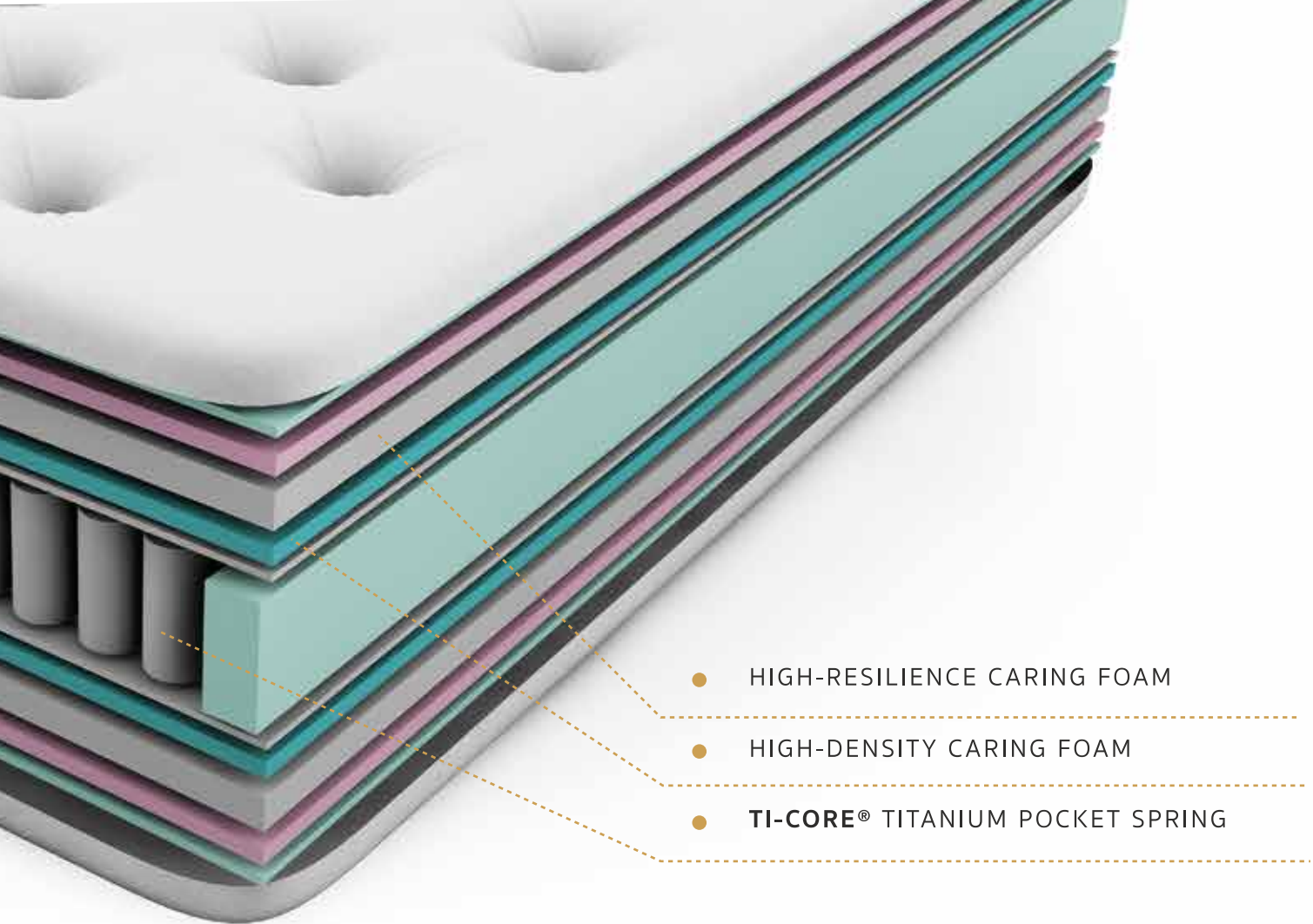

- HIGH-RESILIENCE CARING FOAM
- HIGH-DENSITY CARING FOAM
- **TI-CORE®** TITANIUM POCKET SPRING

## **HIGH RESILIENCE CARING FOAM**

Easily conforms to your body contour regardless of how many times you toss and turn your body night with different sleeping positions, our High-resilience Caring Foam is specially made with a dedicated formula during the mixing process, to ensure great body care at all times.

## **HIGH-DENSITY CARING FOAM**

In compliance with international manufacturing standards, we use only the highest quality High-density Caring Foam without any harmful chemicals, which is extremely safe for you and your family.

## **SUPREME SPINE SUPPORT**

Our unique High-resilience and High-density Caring Foam are carefully placed on top of the dedicated Ti-core® Titanium Pocket Spring system, which enhances the overall comfort level and offers ultimate back care and supreme spine support.



# BIOTECH

## BIODEGRADABLE ECO-GREEN FOAM

### SUSTAINABLE COMPONENTS

Our foam made with a combination of liquid polymers, water, and other biodegradable components. It is recognised as eco-green foam, which is certified by FIRA.

### SUPER SAFE CONSUMPTION

Besides using biodegradable components, our BioTech Eco-green foam also comes with anti-bacteria treatment that gives you and your family a super safe healthy sleep at all times.



**BIODEGRADABLE  
COMPONENTS**



**FIRA  
CERTIFIED**



**SAFE  
CONSUMPTION**



**HEALTHY  
SLEEP**



**ANTI-  
BACTERIA**





## BURVIAN

---

BOYTEKS® Cooler Knitted Fabric Cover

---

Quad-HDCoil® Ti-core® Titanium Pocketed Spring

---

Belgium 7-zone Targeted Body Support 100% Natural Latex

---

16" | 41cm | 4 Layers Spring System

---

SPINASHIELD Hybrid System

---

High-density Caring Foam

---

FOAMGUARD® Protective Barrier Foam

---



## COBELLE

---

BOYTEKS® Cooler Knitted Fabric Cover

---

Tri-HDCoil® Ti-core® Titanium Pocketed Spring

---

Belgium 7-zone Targeted Body Support 100% Natural Latex

---

16" | 41cm | 3 Layers Spring System

---

SPINASHIELD Hybrid System

---

High-density Caring Foam

---

FOAMGUARD® Protective Barrier Foam

---



## LIMORA

---

BOYTEKS® Cooler Knitted Fabric Cover

---

Duo-HDCoil® Ti-core® Titanium Pocketed Spring

---

Belgium 7-zone Targeted Body Support 100% Natural Latex

---

15" | 38cm | 2 Layers Spring System

---

SPINASHIELD Hybrid System

---

High-density Caring Foam

---

FOAMGUARD® Protective Barrier Foam

---



## MARVO

---

BOYTEKS® Cooler Knitted Fabric Cover

---

Duo-HDCoil® Ti-core® Titanium Pocketed Spring

---

Belgium 7-zone Targeted Body Support 100% Natural Latex

---

14" | 36cm | 2 Layers Spring System

---

SPINASHIELD Hybrid System

---

High-density Caring Foam

---

FOAMGUARD® Protective Barrier Foam

---



## H A V U R

13" | 33cm

---

BOYTEKS® Cooler Knitted Fabric Cover

---

SPINASHIELD Hybrid System

---

Ti-core® Parallel Titanium Pocketed Spring

---

High-density Caring Foam

---

Imported 100% Natural Latex

---

FOAMGUARD® Protective Barrier Foam

---



## BRONN

12" | 30cm

---

BOYTEKS® Cooler Knitted Fabric Cover

---

---

SPINASHIELD Hybrid System

---

---

Ti-core® Parallel Titanium Pocketed Spring

---

---

High-density Caring Foam

---

---

Imported 100% Natural Latex

---

---

FOAMGUARD® Protective Barrier Foam

---



**YEAR 1888**

Established brand with own building in Detmold, Germany.

**YEAR 2000**

Worldwide penetration from Europe to Asia, leading the furniture & bedding industries.



**YEAR 1906**

Honoured with the special award for "Purveyor for Court" from members of the German Royal Family.



**MEISTER OF SLEEP ENGINEERING**  
**LEADING GERMAN INNOVATION**  
**SINCE 1888**



### YEAR 2020

Appointment of Professor Doctor Baumgart as Hilker Brand Ambassador

Our timeless, modern designs have been inspired by the needs of our customers to better suit their everyday life, since 1888. In the year 1906, the company was honoured with the special award for “Purveyor for Court” from members of the German Royal Family. During that time, the family coat of arms was created, which represents the relation to the Hilker brand.

To go above and beyond in providing premium quality for your comfort, Professor Doctor Baumgart, our brand ambassador is available to advise on the health aspect of our mattress, especially in relation to healthy sleep. He is an internationally recognised German internist and cardiologist and partner of the specialist centre Preventicum in the city of Essen.



Widely recognised in its home country of Germany, Hilker is one of the world's leaders in the mattress industry. Hilker utilised only the latest sleep technology and premium materials, providing the most advanced, luxurious, and precise sleep solutions to the world. The Hilker family crest arose after being honoured as the "Purveyor to the Court" by the German royal family in 1906, which reflects the reliability of the brand.

**HILKER1888MATTRESS.COM**



With Hilker, you're choosing a dependable product that's built to last, and with our 10-year guarantee, we will make sure you will always sleep like royalty.



All Hilker products are TUV Rheinland Certificate approved, tested for carcinogenic, mutagenic, and reproductive toxic substances as well as the total VOC (TVOC) concentration and thus safely performing against health-hazardous and pollutive elements.



 [SWEETDREAM.SG](http://SWEETDREAM.SG)

 [Sweet Dreams Furniture](https://www.facebook.com/SweetDreamsFurniture)

 [@SweetDreams\\_sg](https://www.instagram.com/SweetDreams_sg)

 (+65) 9119 3786  
(+65) 8338 8127

 12 Little Road #05-01,  
S(536986)

Visit Our Website

